



DensShield[®]
Tile Backer

Questions & Answers



DENSSHIELD[®] Questions & Answers



Product Description

DensShield® Tile Backer is designed for use as a substrate for tile walls, ceilings, countertops and commercial and residential floor applications in high moisture areas. The special moisture-resistant, treated core—covered front and back by fiberglass mats—is lighter than the leading cement board brands (based on 1/2" [12.7 mm] comparison). The unique construction (an outer grey heat-cured, copolymer, moisture-resistant coating placed over fiberglass mats and a moisture-resistant, treated core) makes it a preferred product for applications in high moisture areas.

Applications

- Bathrooms (shower and tub walls, floors and ceilings)
- Kitchens (backsplash, walls, countertops and floors)
- Residential and light commercial floors
- Non-tiled walls and ceilings in indoor swimming pool enclosures
- Residential steam rooms

Available Sizes

1/2" (12.7 mm) **DensShield Tile Backer** panels are available for walls, floors and ceilings in the following widths:

- 4' x 5' (1220 mm x 1524 mm)
- 32" x 5' (813 mm x 1524 mm)
- 4' x 8' (1220 mm x 2438 mm)

5/8" (15.9 mm) **DensShield® Fireguard® Tile Backer** panels may be used in appropriate fire-rated assemblies and are available in one width:

- 4' x 8' (1220 mm x 2438 mm)

1/4" (6.4 mm) **high-density DensShield Tile Backer** underlayment panels for countertops and floors are available in one width:

- 4' x 4' (1220 mm x 1220 mm)

For More Information

For complete technical information, independent test data, application instructions, warranty and specifications, visit our web site at

www.DensShield.com.

 **Georgia-Pacific**
DensShield[®]
Tile Backer

DensShield® Tile Backer

FEATURES	ADVANTAGES	BENEFITS
Protects Tile Installation		
<ul style="list-style-type: none"> • Unique grey built-in acrylic coating • Moisture-resistant treated core • 5/8" (15.9 mm) DensShield® Fireguard® Tile Backer may be used in select assemblies with one- and two-hour fire ratings • Mold-resistant • GREENGUARD Microbial-Resistant 	<ul style="list-style-type: none"> • Protects tile installation and helps stop moisture migration into wall cavity • Outperforms cement backers by stopping moisture at the surface • Virtually no wicking compared to cement backer boards • Achieve fire rating without tile and insulation in the assembly (5/8" [15.9 mm] DensShield Fireguard) 	<ul style="list-style-type: none"> • Ideal for floors, showers, kitchens, countertops and other wet, high-humidity areas • Fewer callbacks
Easy To Install		
<ul style="list-style-type: none"> • Scores and snaps easily with a standard utility knife • Light weight; lighter than the leading cement board brands (1/2" [12.7 mm] comparison) • Easy-to-handle sizes 	<ul style="list-style-type: none"> • Non-abrasive to fixtures in tub and shower installations • Can fasten close to edge for easy application over plywood flooring and wall framing 	<ul style="list-style-type: none"> • Lower installed cost than cement backer boards
Strong And Durable		
<ul style="list-style-type: none"> • Flexural strength is approximately the same in parallel or perpendicular directions 	<ul style="list-style-type: none"> • Wall and ceiling applications can be either parallel or perpendicular to the supporting member 	<ul style="list-style-type: none"> • Fewer panel joints
Limited Warranty		
<ul style="list-style-type: none"> • Lifetime limited warranty for residential installations.* • 20-Year limited warranty for commercial installations.* 		<ul style="list-style-type: none"> • Peace of mind for contractor and home owner

* See warranties for complete terms, conditions and limitations. For a copy of the warranty or for technical details, visit our web site at www.DensShield.com.

DensShield® Tile Backer outperforms cement board and is easier to install.

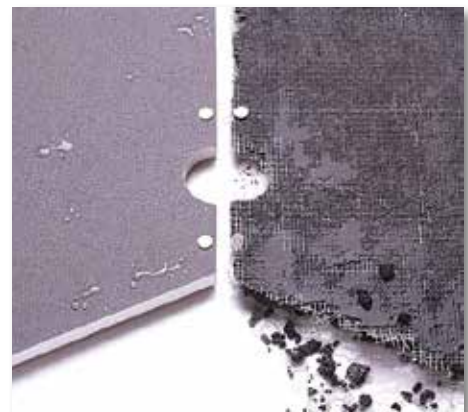

What is DensShield[®] Tile Backer?

DensShield[®] Tile Backer is Georgia-Pacific Gypsum's revolutionary substrate for installing tile in interior areas that are susceptible to moisture. DensShield Tile Backer is designed for interior tile installations on ceilings, walls, floors and countertops. In industry-approved tests, DensShield Tile Backer has achieved a residential and light commercial rating for floors.

A quality tile installation requires a sound substrate that is unaffected by moisture. Moisture can cause deterioration of the substrate, resulting in a tile failure. Plywood is a poor substrate for direct tile installations because moisture can cause it to warp and buckle, resulting in delamination or separation of the tile and mortar from the board.

Paper-faced, moisture- and mold-resistant gypsum board is adversely affected by moisture. When moisture migrates into the core, it wicks or moves up the board causing the paper to separate from the core and the tile to fall off. This is why greenboard and paper-faced, mold-resistant gypsum boards are not approved by 2012 IRC and IBC for use in wet areas. Conversely, DensShield Tile Backer panels are approved by code and provide a sound substrate for tile and offer outstanding protection from moisture. In addition, DensShield Tile Backer doesn't wick moisture.

Cement backers such as Durock[®], HardiBacker[®], PermaBase[®] and Wonderboard[®] also provide a sound substrate for tile installation and have long been a favorite of tile contractors. Cement backers, however, are hard to install because they are heavy and difficult to score, cut and fasten without the use of special tools and fasteners. DensShield Tile Backer actually outperforms cement backers in moisture protection. Although cement backers are unaffected by moisture, they allow the passage of moisture through to the wall cavity if no additional moisture barrier is used. With DensShield Tile Backer, no additional moisture barrier is required or recommended. It's also lighter and much faster to install.

For these reasons, DensShield Tile Backer panels are truly the ultimate tile backer product. The high cost of redoing a tile job due to moisture damage makes it a bargain. It is priced similarly to cement backers.

On the market since 1987, DensShield Tile Backer has proven to be a viable and formidable competitor to cement backers and other premium backer boards because of these unique design characteristics:

1. GREY, HEAT-CURED ACRYLIC SURFACE COATING

The grey coating on the tile application side of DensShield Tile Backer is a multi-coat, heat-cured, copolymer acrylic that provides a moisture barrier that stops water and retards moisture at the surface. This coating also serves as an ideal bondable surface for a variety of tile setting mortars and mastics. Because of this coating, no additional moisture barrier is required or recommended behind DensShield Tile Backer to protect the wall cavity.

2. FIBERGLASS MATS ON BOTH SIDES OF THE PANEL

To add strength and rigidity, the core has fiberglass mats on both sides of the panel that are impregnated into the panel in the manufacturing process. This construction, combined with the tile-side acrylic coating, eliminates the possibility of delamination associated with paper-faced gypsum board. The added strength also means that DensShield Tile Backer can be fastened either vertically or horizontally to the supporting framing members, which can result in fewer joints.

3. MOISTURE-RESISTANT TREATED CORE

The high-performance, moisture-resistant core of DensShield Tile Backer is specially treated to add further moisture protection. The specially engineered core doesn't allow DensShield Tile Backer panels to wick moisture like competing cement board products.

DensShield[®] Tile Backer Application Chart

Size	Application	Advantages
½" x 4' x 5' (12.7 mm x 1220 mm x 1524 mm)	walls, floors, ceilings, countertops	Allows contractors to install DensShield [®] Tile Backer in larger bath and garden tub surrounds with fewer joints and less waste.
½" x 32" x 5' (12.7 mm x 813 mm x 1524 mm)		Works well for smaller tub surrounds, reducing joints and waste. Lighter and easier to install than cement board panels. Designed to align with standard construction framing of 16" (406 mm) o.c.
½" x 4' x 8' (12.7 mm x 1220 mm x 2438 mm)		Panel of choice for large residential and commercial applications. Large size reduces waste and number of joints that require treatment. Weighs 12 lbs (5.4 kg) to 32 lbs (15 kg) lighter than cement board depending on manufacturer.
¼" x 4' x 4' (6.4 mm x 1220 mm x 1220 mm)	floors, countertops	Perfect as underlayment for floors and countertops. The ¼" (6.4 mm) thickness keeps the floor profile low while still providing ultimate performance—the 4' x 4' (1220 mm x 1220 mm) panel makes it easy to offset panel joints.
⅝" x 4' x 8' (15.9 mm x 1220 mm x 2438 mm)	walls, floors, ceilings, countertops	Meets Type X requirements (per ASTM C1178) for use in appropriate fire-rated assemblies. Ideal for commercial and multi-family construction. Aligns perfectly with other ⅝" (15.9 mm) gypsum boards in fire-rated assemblies. No shimming necessary when moving from tiled to non-tiled areas.

Testing and Code Recognition

Standards and Code Compliance

DensShield® Tile Backer in ¼" (6.4 mm), ½" (12.7 mm) and ⅝" (15.9 mm) thicknesses conforms to current IRC and IBC codes for use as a tile backer in tub and shower areas and is manufactured to meet ASTM C1178 as a fiberglass mat gypsum substrate for use as tile backer. DensShield Tile Backer also has the following evaluation reports:

- ICC-ES product approved
- New York City MEA 65-88-M

Floor Test—Robinson Floor Test/ASTM C627

An independent testing agency conducted the Robinson Floor Test (ASTM C627) on DensShield Tile Backer by constructing assemblies and subjecting them to tests of increasing weight and durability. Ultimately, DensShield Tile Backer panels were able to withstand pressure equivalent to three stacked refrigerators without damage, resulting in ¼" (6.4 mm) and ½" (12.7 mm) DensShield Tile Baker panels achieving a residential and light commercial rating for floors.

Adhesion Bond Test

CTC-Geotek conducted bond-adhesion tests comparing adhesion capabilities of DensShield Tile Backer and cement backers using various setting materials. The tests concluded that bonds with DensShield Tile Backer are as good as, if not better than, bonds with cement backers.

Shower Test

In a test by an independent testing laboratory, DensShield Tile Backer was subjected to a shower of water at 110°F (43.3°C), 12 minutes per hour, 24 hours a day, 7 days a week for six months. The installation had no grout between the tiles. No deterioration occurred to either the DensShield Tile Backer board, the framing members or the wall cavity. The DensShield Tile Backer test was designed to represent 12 years of regular shower use. **Although cementitious backer boards would not likely deteriorate under the same conditions, the possibility exists for deterioration of framing members and the wall cavity due to water infiltration if a moisture barrier isn't positioned behind the cementitious backer unit.**

Percolation Test

The percolation test helps determine if an additional moisture barrier should be installed. The test consists of a 2" (51 mm) diameter tube, 48" (1220 mm) long, bonded to test samples with silicone sealant. The tube is filled with water and after 48 hours, the remaining water is measured (minus evaporation). During testing, the following occurred:

- ⅛" (3 mm) of water passed through DensShield Tile Backer
- 19" (483 mm) of water passed through one cementitious tile substrate sample
- 43" (1092 mm) of water passed through another sample of cement board.

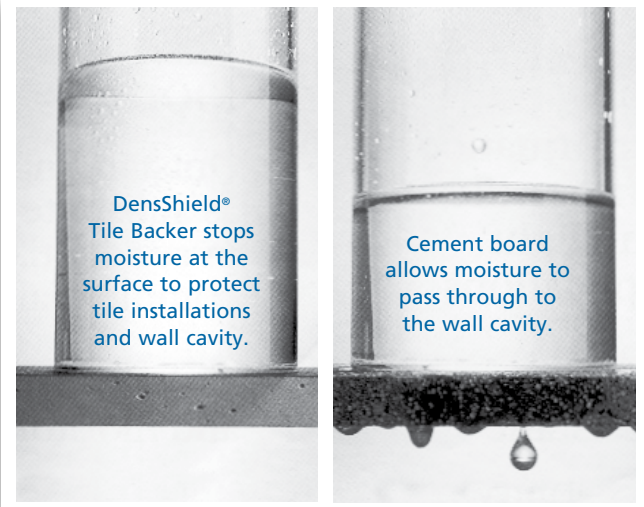

The test demonstrates DensShield Tile Backer stops water at the surface, while cement boards allow water to pass through their porous construction. The Tile Council of North America requires the use of a membrane in wet areas for cement backer boards but does not require a membrane for DensShield Tile Backer since DensShield Tile Backer panels have a built-in moisture barrier that stops moisture at the surface.

Water Vapor Transmission

ASTM E96 test method intends to measure the rate of water movement through a material's surface over a period of time. This is accomplished under controlled conditions of temperature and humidity. It is used to assess the passage of water vapor through paper, plastic films, other sheet materials, fiberboards, wood products, gypsum and plaster products.

Mold Resistance Test

Tests conducted by SGS U.S. Testing Company Inc., an independent testing service based in Tulsa, OK, have indicated that DensShield Tile Backer effectively resists mold growth. When tested, as manufactured, in accordance with ASTM D3273, DensShield Tile Backer has scored a 10, the highest level of performance for mold resistance under the ASTM D3273 test method.*

DensShield Tile Backer is listed as a GREENGUARD microbial-resistant product by a leading third-party organization, UL Environment. This listing means DensShield Tile Backer, which features fiberglass mats, resists microbial contamination including mold growth. The microbial-resistant test is based on ASTM Standard D6329, a testing standard set by ASTM International, which develops testing guidelines and procedures for building materials, products, systems and services.

*The score of 10, in the ASTM D3273 test, indicates no mold growth in a 4-week controlled laboratory test. The mold resistance of any building product when used in actual job site conditions may not produce the same results as were achieved in the controlled, laboratory setting. No material can be considered mold proof. When properly used with good design, handling and construction practices, Dens® Brand gypsum products provide increased mold resistance compared to standard paper-faced wallboard products. For more information, visit www.buildgp.com/safetyinfo.

GENERAL INSTALLATION QUESTIONS

1 Is the acrylic coated side of DensShield[®] Tile Backer installed face out?

Yes. The DensShield[®] Tile Backer panel should be positioned next to framing with the acrylic coated (grey) side facing away from studs. Apply mortar or mastic and tile to the acrylic coated (grey) side of DensShield Tile Backer panels. The built-in acrylic coating stops moisture penetration at the surface.

2 How do I score and cut DensShield Tile Backer?

DensShield Tile Backer may be cut cleanly by scoring and snapping with a standard utility knife, working from the grey facing side of the panel.

3 Can I install DensShield Tile Backer either parallel or perpendicular to the wall framing?

Yes. The flexural strength of DensShield Tile Backer panels is approximately the same in both parallel and perpendicular directions. This allows wall and ceiling applications to be installed either parallel or perpendicular to the supporting members and results in fewer panel joints. DensShield Tile Backer can be installed over both wood framing and steel stud construction by spacing fasteners 6" (152 mm) o.c. along studs for wood or a minimum 20-gauge (33 mils) steel framing.*

**For equivalent and effective gauge steel studs, we have no evaluation or installation recommendations.*

4 Can DensShield Tile Backer be used in non-tile wet area applications?

Yes. In many applications, DensShield Tile Backer is used for its moisture barrier and moisture-resistant qualities for non-tiled walls and ceilings. There are several methods for finishing the panel depending on the environment. The environments of non-wet, high humidity and wet areas are described in the DensShield Tile Backer technical brochure (GP Item #622598). Each environment has its own finishing recommendation. A finishing method must never be used in a more severe environment than described.

5 Will the surface coating and mat separate or delaminate from the core?

The copolymer surface coating is heat cured, will not liquefy and is bonded to the fiberglass mat and the core. The fiberglass mats are mechanically attached by being embedded into the core during manufacture of the board to help prevent delamination. DensShield Tile Backer is backed by a limited warranty against delamination as a result of normal use conditions. For complete warranty details, visit www.DensShield.com.

6 What does it mean when Georgia-Pacific says DensShield panels have high resistance to wicking?

Like fuel travels up a wick of an oil lamp, the same occurs when other tile backer boards are exposed to water. When water wicks or travels up the board, it may not harm the board itself. But when it infiltrates the wall cavity, moisture can cause many problems including, but not limited to, dry rot, rusting fasteners, color change of tiles and wet insulation. Type 1 mastic loses its bond during prolonged wetting. When insulation becomes wet, it loses its effectiveness. This does not mean, however, that DensShield Tile Backer can be permanently immersed in water.

7 Does the Tile Council of North America (TCNA) recognize DensShield Tile Backer?

Yes. DensShield Tile Backer is found in 16 assemblies in the TCNA handbook for floors, walls, ceiling, tubs and showers and is manufactured to meet ASTM C1178. Georgia-Pacific has long been a supporter of the TCNA and is active in other industry associations.

8 Can I use DensShield® Tile Backer in fire-rated wall assemblies?

Yes. $\frac{5}{8}$ " (15.9 mm) DensShield® Fireguard® Tile Backer is manufactured to meet Type X requirements (per ASTM C1178) and can be substituted in any generic assemblies using a $\frac{5}{8}$ " (15.9 mm) Type X gypsum board. This permits the use of numerous 1-hour and 2-hour assemblies for both wood and metal frame construction. Transition to regular $\frac{5}{8}$ " (15.9 mm) Type X board is also minimized.

9 Do DensShield panels meet 2012 IRC and IBC codes for wet areas?

Yes. DensShield Tile Backer is manufactured to ASTM C1178 which is one of three standards acceptable as a backer board in tub and shower areas.

FASTENING

10 What is the correct wall and ceiling framing requirements for DensShield Tile Backer?

Maximum wall framing spacing for $\frac{1}{2}$ " (12.7 mm) DensShield Tile Backer panels is 16" (406 mm) o.c. without blocking or 24" (610 mm) o.c. with blocking. Maximum wall framing spacing with $\frac{5}{8}$ " (15.9 mm) DensShield Tile Backer is 24" (610 mm) o.c. with or without blocking. For ceilings, framing should be spaced no greater than 12" (305 mm) o.c. for $\frac{1}{2}$ " (12.7 mm) DensShield Tile Backer or 16" (406 mm) o.c. for $\frac{5}{8}$ " (15.9 mm) thickness. Panels should be applied perpendicular to framing for ceiling applications.

11 How is DensShield Tile Backer fastened in place?

No special or unique fasteners are required to fasten DensShield Tile Backer panels in place. For wood studs: galvanized roofing nails, rust-resistant drywall screws or bugle head deck screws. Fasteners should be long enough to penetrate at least $\frac{3}{4}$ " (19 mm) into the wood framing members. For metal framing: a variety of rust-resistant screws can be used.

12 What is the fastener spacing?

For walls and ceilings in either wood or metal framing, fasteners are to be spaced no more than 6" (152 mm) o.c. along framing members. For floor applications, fasteners should be spaced no more than 8" (203 mm) o.c. in both directions. Larger crown corrosive-resistant chisel point staples can be used on $\frac{1}{4}$ " (6.4 mm) products and spaced every 2" (51 mm) on edge and 4" (102 mm) in field.

13 Should the fasteners be countersunk?

No. Fasteners should be flush with the coated surface and are not to be countersunk.

14 How do you repair damage to the surface coating of DensShield Tile Backer panels or areas where fasteners are countersunk?

Minor damage to the surface can easily be repaired by covering the indented or blemished area with standard tile setting material.

TAPING AND BEDDING

15 Should I tape the joints? If so, what kind of tape should I use with DensShield Tile Backer?

Yes. Apply a self adhesive 2" (51 mm) wide fiberglass mesh tape over all joints and corners. This is the same type of tape used for taping cement board joints. Then, embed the tape with the same material used to set tiles. Do not use all-purpose or setting type drywall compounds. Pull tile setting materials tightly over the joint to reduce crown in the joint area. Allow tile setting material to dry prior to setting the tiles.

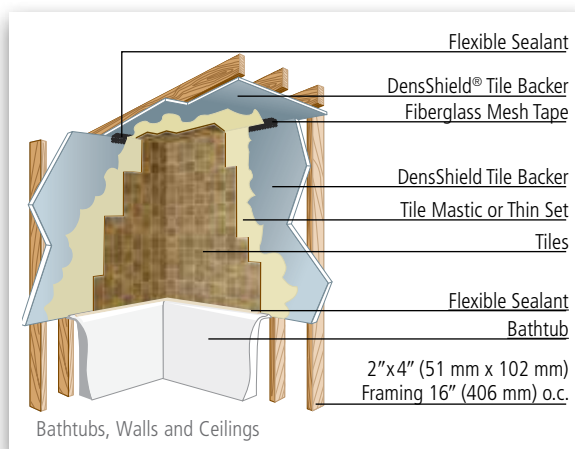

MOISTURE PROTECTION

16 I have been told by professional installers that DensShield® Tile Backer can provide a true moisture-resistant envelope by using flexible sealant in corners where adjacent DensShield Tile Backer panels come together. Is this true?

Yes. By caulking the intersecting corners of DensShield Tile Backer panels and around a tub base or shower pan with flexible sealant, a moisture-resistant envelope can be established. The sealant should be applied to the DensShield Tile Backer corners PRIOR to taping the joints. This “caulk” joint should be as small as possible and should not spread over the face of DensShield Tile Backer panels because not all setting materials will adhere to a flexible sealant.

17 Must an additional moisture barrier be supplied and installed when using DensShield Tile Backer panels?

No. The grey face (tile side) of DensShield Tile Backer has a heat cured acrylic coating which is a built-in moisture barrier and vapor retarder so that no additional moisture barrier is required. In fact, an additional moisture barrier to the back side of DensShield Tile Backer is NOT recommended. Prior to the tile installation it is permissible to apply a fluid applied membrane to the face of DensShield Tile Backer for enhanced moisture resistance.

TILING

18 Are special tile setting materials needed to work with DensShield Tile Backer panels?

No. DensShield Tile Backer requires the same type of setting materials as any other backer board. No special mastics or thin-sets are required. To set tile, use a latex portland cement mortar, or other products recommended by the mortar manufacturer. Follow the tile setting manufacturer’s instructions for applying tile setting material. Dry-set or thin-set latex-modified mortars are most commonly used with DensShield Tile Backer and cement backers. Use only latex-modified mortars in floor applications.

19 How well do different setting materials bond with the grey DensShield Tile Backer panel coating?

DensShield Tile Backer performs equal to or better than cement boards and fiber cement backers with all popular setting materials.

DensShield® Tile Backer is ideal for bathrooms, showers, floors, kitchens and other wet, high humidity areas.



20 Is there a limit on tile sizes and thicknesses for walls and ceilings?

Today's tile comes in a variety of sizes, shapes and weights and most are appropriate over DensShield Tile Backer for walls, ceilings, floors and countertops. For large format tile, consult the tile manufacturer or appropriate authority for proper system design and deflection criteria. When stone or marble tile is applied to DensShield Tile Backer in floor or wall installations, the system should be designed for a deflection of $L/720$.

21 Can damaged tile easily be replaced when DensShield® Tile Backer is used as the tile backer?

Yes. Here are some general guidelines and procedures:

Large Areas

1. Remove affected tile area and surrounding tiles from stud to stud. This includes removing the DensShield Tile Backer panels.
2. Fasten additional studs known as "scabs" to the sides of the original studs for support of the new DensShield Tile Backer panels.
3. Caulk the edges of the new DensShield Tile Backer panels with a flexible sealant so the joint is waterproof.
4. After caulk has cured, install new tiles and grout.

Small Areas

1. Remove grout from around the affected area.
2. Carefully score through just the acrylic finish around the affected area.
3. Remove the tile, including the acrylic DensShield Tile Backer finish, exposing the silicone-treated core.
4. Use a penetrating sealer/primer such as shellac primer or solvent-based primer to seal the exposed core, allow to dry.
5. Install tile with either a mastic or modified thin-set.
6. Re-grout the area.

SHOWERS

22 How do you finish DensShield Tile Backer panels around the shower pan?

The shower pan or rubber membrane must be adequately sloped to the open drain or weep hole detail to permit proper water drainage. Caulk the space between the mortar bed and DensShield Tile Backer edge with flexible caulk.

- Showers with curbs—apply waterproof membrane up the walls a minimum of 2" (51 mm) and a maximum of 4" (102 mm) above curb.
- Showers without curbs—apply waterproof membrane up the walls a minimum of 6" (152 mm) and a maximum of 8" (203 mm).

DensShield Tile Backer panels should not be used in shower curbs. DensShield Tile Backer can be installed in the shower pan if part of an approved system.

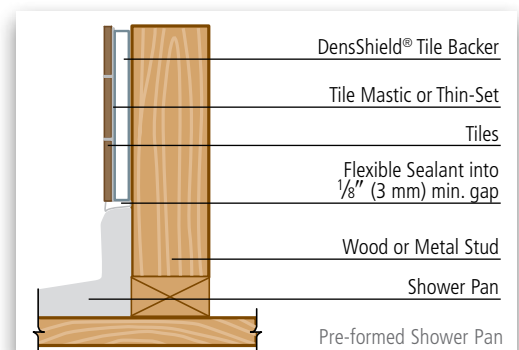
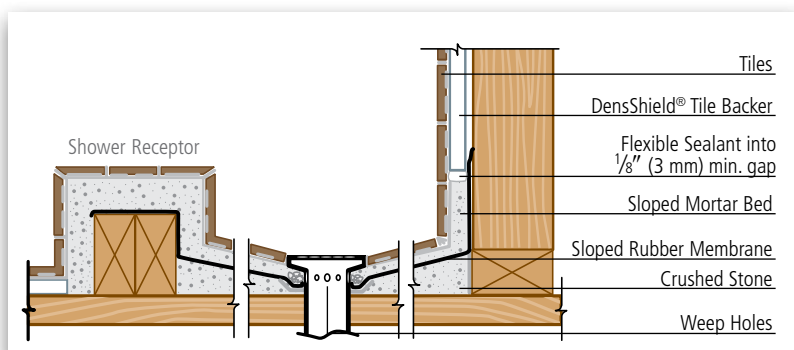

23 How can DensShield® Tile Backer reduce waste?

32" x 5' (813 mm x 1,524 mm) DensShield® Tile Backer saves you time and money. There will be only 1½ sq. ft. (0.14 m²) of waste with DensShield Tile Backer for a standard 60" (1,524 mm) tub surround and 4" x 60" (102 mm x 1,524 mm) waste used to cut 2" x 12" (51 mm x 305 mm) or 2" x 14" (51 mm x 356 mm) legs for typical tub surround.

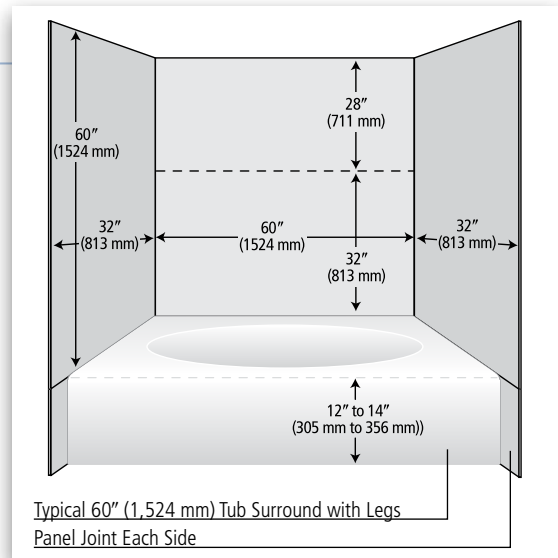

24 Can DensShield Tile Backer panels be used in a one-coat method wall tile system?

Yes, DensShield Tile Backer can be installed as a baseboard for a traditional reinforced floated wall tile system (using metal lath) attached to the framing. DensShield Tile Backer may be hung either vertically or horizontally for wall applications.

- Grey coated side should always face out, away from the studs.
- Framing should be spaced no greater than 16" (406 mm) o.c.
- Attach DensShield Tile Backer, spacing fasteners 6" (152 mm) o.c. along studs for wood or minimum 20-gauge* (33 mils) steel framing.
- Attach membrane and lath per lath and membrane manufacturers' guidelines. Apply mortar bed per TCNA assembly W222. Membrane (ANSI A-2.1.8) shall be installed such that water is continually sloped toward the drain.

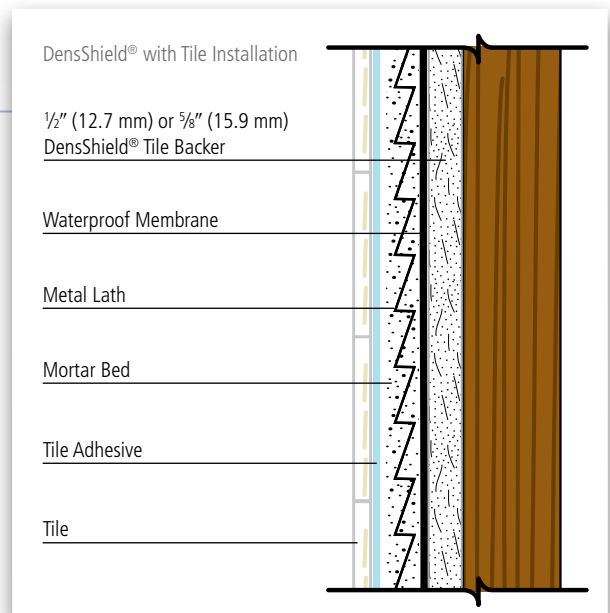

*For equivalent and effective gauge steel studs, we have no evaluation or installation recommendations.

25 Can DensShield® Tile Backer be used in floor applications?

Yes. Both ¼" (6.4 mm) and ½" (12.7 mm) DensShield® Tile Backer can be used in floor applications. Both of these thicknesses passed the Robinson Floor Test, the industry standard floor test for residential and light commercial ratings. The Robinson Floor Test (ASTM C627) is designed to determine how a tile assembly holds up under extreme wear and weight conditions. DensShield Tile Backer achieves the same light commercial rating as cement and fiber cement backers.

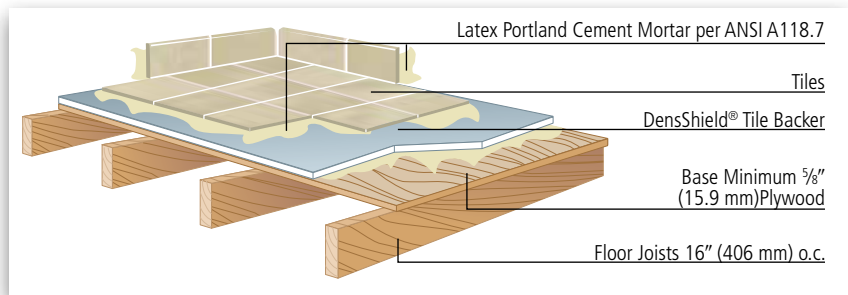

26 DensShield Tile Backer seems softer than cement boards. Does it have the same floor ratings?

DensShield Tile Backer is rated for residential and light commercial floors. ¼" (6.4 mm) DensShield Tile Backer panels have a compressive strength of approximately 1200-1500 lbs psi, and ½" (12.7 mm) DensShield Tile Backer has a compressive strength of between 450 and 600 lbs psi. That means that it would typically take a load of 450 to 600 lbs psi to start to crush ½" (12.7 mm) DensShield Tile Backer. When a load is applied to the floor tile, the tile distributes the load over its entire area.

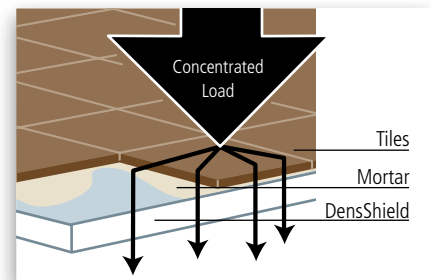

The drawing above depicts how a load is distributed over the surface of a tile and carried by DensShield Tile Backer. With a minimum tile size of 2" x 2" (51 mm x 51 mm) a load of over 1800 lbs. (816 kg) is needed to overcome the compressive strength of DensShield and floor assembly.

27 Is DensShield® Tile Backer installed any differently than other tile backers in flooring applications?

No. DensShield Tile Backer in either the ¼" (6.4 mm) or ½" (12.7 mm) thickness is installed the same way, following the guidelines below:

- Laminate DensShield Tile Backer panels, grey coated side up, to 5/8" (15.9 mm) minimum APA exterior grade plywood subfloor or 3/4" (19 mm) OSB using a latex portland cement mortar (complying with ANSI A118.4) liberally applied with a ¼" (6.4 mm) square notched trowel. This is the same recommendation as Tile Council of North America (TCNA).
- Embed DensShield Tile Backer into mortar while still pliant (do not exceed open time). Stagger DensShield Tile Backer joints from subfloor joints; fasten with 1¼" (32 mm) galvanized roofing nails or corrosion-resistant screws. Avoid driving fasteners into the joists to avoid nail pops. Space fasteners no greater than 8" (203 mm) o.c. in both directions. Drive fasteners flush with the surface—do not countersink. Apply 2" (51 mm) fiberglass mesh tape over joints and embed with latex portland cement mortar.
- Staples: (¼" [6.4 mm] DensShield Tile Backer only) ¼" (6.4 mm) or larger crown corrosive resistant chisel-point staples equal to approximately the total thickness of underlayment and subfloor. Staples shall be placed 2" (51 mm) o.c. around the perimeter and 4" (102 mm) o.c. in the field ensuring that the staples are between 3/8" (3 mm) and ½" (12.7 mm) from ends and edges.
- Apply flooring grade ceramic tile with latex portland cement mortar (ANSI A118.4). Tile must be a minimum size of 2" x 2" (51 mm x 51 mm) or larger. Full thickness thresholds should be used, butted against the edge of DensShield Tile Backer panels and flush with the tile surface.
- Use latex portland cement floor grout (ANSI A118.6).
- PRIOR to tile installation, all backer boards need to be protected from very heavy loads and construction traffic such as moving appliances. Protection such as plywood should be laid down in these areas.

28 Can DensShield® Tile Backer be used in residential steam rooms?

Yes. But follow the specific installation recommendations below:

1. Do not install a vapor barrier behind DensShield® Tile Backer.
2. Apply DensShield Tile Backer to all wall and ceiling surfaces that will constitute the steam room using corrosion-resistant fasteners 6" (152 mm) o.c. along all framing members. All parts of the steam room shall be tiled. **Caution:** Exposing materials such as wallpaper, joint compound, drywall or untiled DensShield Tile Backer panels may result in unsatisfactory performance of these materials.

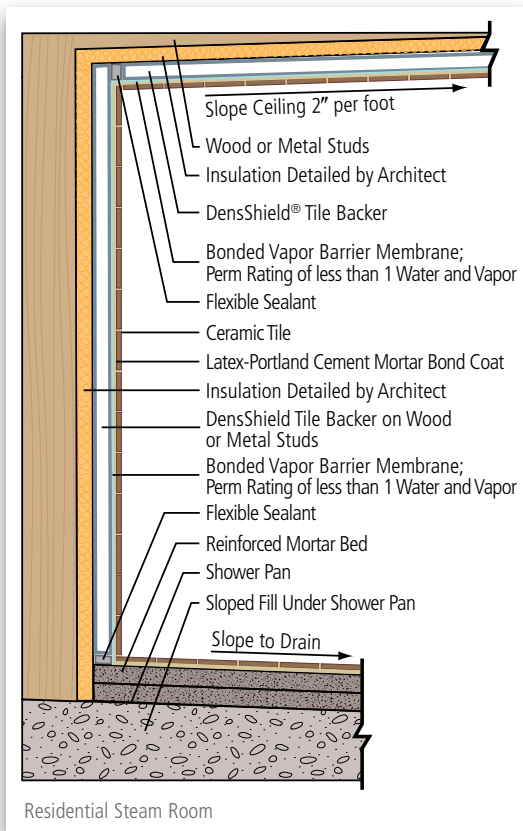

Residential Steam Room

3. Tape all corners and joints with a self-adhering fiberglass mesh tape and embed with a latex modified thin set mortar. Spot fasteners that were incidentally countersunk and other surface deformations.
4. Roller apply a liquid waterproofing material such as LATICRETE® 9235 Waterproofing Membrane, or equal, directly over the entire DensShield Tile Backer surface covering all fasteners, corners and joints. As an alternative to taping corners and joints in step 3, corners and joints may be finished with a liquid membrane manufacturer's taping procedures for vertical surface. See manufacturer's directions.
5. Seal around all penetrations and where DensShield Tile Backer meets dissimilar materials with a flexible silicone sealant.
6. Apply tile with a latex modified thin-set mortar per manufacturer's recommendations.
7. Use flexible sealant as grout in all corners.
8. Use unfaced fiberglass insulation in wall cavity to retard heat. If using kraft-faced insulation, cut 4" (102 mm) slits in kraft paper every 3" (76 mm) in both directions.

LIMITATION: Residential applications only. No larger than 48 sq. ft. (4.5 m²).

Operation and Maintenance—The steam generation unit should be timer-controlled to avoid incidental lengthy exposure. Maintenance of grout and caulking of corners due to movement should be performed when required.

Compare DensShield® Tile Backer to Competing Tile Backer Substrates

Features/Benefits	DensShield® Tile Backer	Cement Backer	Fiber Cement Backer	Fiber Gypsum Panel
Suitable for wet areas (meets 2012 IRC and IBC codes)	YES	YES	YES	only IRC
Protects wall cavity from moisture intrusion without additional vapor barrier	YES	NO	NO	NO
Built-in surface moisture barrier	YES	NO	NO	NO
Superior fire resistance	YES	NO	NO	NO
Lighter weight (depending on panel thickness)	YES	NO	NO	NO
Non-abrasive to tubs, shower pans and other fixtures	YES	NO	YES	YES
Easy to fasten	YES	NO	NO	NO
Cuts easily, cleanly with standard utility knife	YES	NO	NO	NO
Accepts mortars/mastic for tile installation	YES	YES	YES	YES
Available in 32" x 5' (813 mm x 1,524 mm), 4' x 5' (1,220 mm x 1,524 mm) and 4' x 8' (1,220 mm x 2,438 mm) panels	YES	NO	NO	YES

29 I want to use DensShield Tile Backer panels in non-wet areas to achieve a smooth finish for paint or wallcovering. How do I cover the rough surface of DensShield Tile Backer?

Apply a skim coat of Georgia-Pacific setting compound, or equivalent, and prime before the application of wallpaper or finish coat.

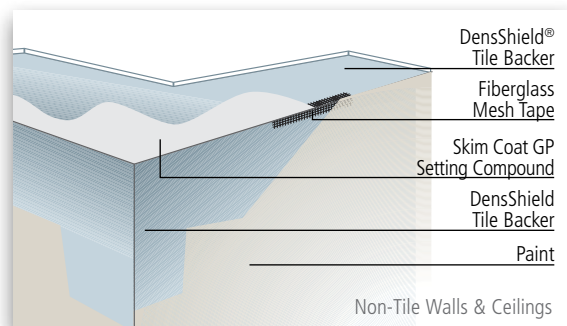

30 Plywood: Why shouldn't plywood be used as a direct substrate for tile?

Plywood has many wonderful uses when used with resilient floor coverings but is not a trouble-free substrate for direct application of ceramic tile. Very simply, wood cures over a long period of time and is not stable. Moisture can cause plywood to move, warp and buckle. Since tiles and cement mortars used in tile installation are not elastic, but instead are rigid, any movement or buckling of the plywood will cause grout failure, tile cracks or the tile to pop off of the substrate.

31 Fiber Cement and Cement Backers: What makes DensShield Tile Backer better than cement backers?

DensShield Tile Backer has a considerable weight advantage over cement backers. DensShield Tile Backer panels are lighter than the leading cement board brands ($\frac{1}{2}$ " [12.7 mm] comparison). Overall, that makes DensShield Tile Backer easier to handle on the job site and faster to install.

Additionally, DensShield Tile Backer is highly resistant to wicking and protects the wall cavity from moisture without an additional vapor barrier. DensShield Tile Backer panels accept mortars or mastic for tile installation. Most importantly, while providing superior moisture protection, DensShield Tile Backer is much easier to score, cut and fasten than cement board.



Fiber Cement

- Weighs about 80 lbs. (36 kg) per $\frac{1}{2}$ " x 4' x 8' (12.7 mm x 1,220 mm x 2,438 mm) panel— not a true $\frac{1}{2}$ " (12.7 mm)
- Requires a membrane behind it when used in wet areas according to the *Handbook for Ceramic Tile* from the Tile Council of North America
- Cut with a carbide tip scoring tool, circular saw or mechanical shears
- Needs special screws



Cement Backer

- Leading cement board weighs approximately 77 lbs (34.93 kg) per $\frac{1}{2}$ " x 4' x 8' (12.7 mm x 1,220 mm x 2,438 mm) (2.4 lbs/sq.ft. [11.7 kg/m²] = 2.4 x 32 = 76.8) *source: USG Durock®
- Requires a membrane behind it when used in wet areas according to the *Handbook for Ceramic Tile* from the Tile Council of North America
- Is more difficult to cut and fasten than DensShield Tile Backer



DensShield® Tile Backer

- Weighs only 64 lbs (29 kg) per $\frac{1}{2}$ " x 4' x 8' (12.7 mm x 1,220 mm x 2,438 mm) panel
- Has built-in moisture barrier to protect tile installation
- Cuts easily with standard utility knife
- No special fasteners required

32 Cement board can be immersed in water for extended periods of time with no effect. What would happen if DensShield Tile Backer was placed in a pail of water for, say, six months?

Other tile backer manufacturers use the water immersion demonstration to show that their product won't warp or buckle and that it will remain stable even when immersed in water for long periods of time. The purpose of such a demonstration is to promote the fact that tile won't fall off of cement backers as a result of moisture damaging the substrate. This demonstration is truly a gimmick and bears no relevance to a real tile installation.

Tile is never installed in interior building areas that are permanently under water. In fact, cement board has a liability in its design in that it allows water to freely pass through it, wetting the plywood in floor applications or framing members in unprotected wall cavities. If a secondary moisture barrier isn't installed, moisture can, and will, damage the stud cavity.

DensShield[®] Tile Backer isn't designed or intended to be permanently immersed in water. The fact is that the built-in acrylic coating on DensShield Tile Backer stops moisture at the surface, preventing tile failures and damage to the wall cavity. Regardless of the water immersion demonstrations of other boards, DensShield Tile Backer is a vastly superior tile backer for the application of installing tile in interiors of buildings.



Cutting is a snap!
 Simply score and snap
 two sides with
 a single blade.
 And the cut edge
 will always be clean.

33 Why does Georgia-Pacific say DensShield[®] Tile Backer saves labor time versus cement board?

- **Cutting.** With DensShield[®] Tile Backer, cutting is as simple as score and snap. The only tool needed is a standard utility knife and the cut edge will always be clean. With heavy cement board, cutting and scoring is difficult. With DensShield Tile Backer panels, cutouts for water supply piping, shower heads, etc., are easily and accurately cut, giving a less expensive and better, cleaner overall tile backer installation than can be achieved with cement backers.
- **Fastening.** DensShield Tile Backer can be fastened close to its edge without edge breakout.

- **Unique Sizes, Less Waste.** DensShield Tile Backer is available in 1/2" (12.7 mm) thick 4' x 5' (1,220 mm x 1,524 mm), 32" x 5' (813 mm x 1,524 mm) and 4' x 8' (1,220 x 2,438 mm) lengths. These sizes blend with conventional 16" (406 mm) o.c. or 24" (610 mm) o.c. wall frame spacing. It is also available in 5/8" (15.9 mm) thick 4' x 8' (1,220 x 2,438 mm) panels. In a shower stall, 4' x 8' (1,220 x 2,438 mm) panels provide full coverage with little or no waste. 5/8" (15.9 mm) DensShield[®] Fireguard[®] Type X requires no furring or aligning of the framing to match 5/8" (15.9 mm) gypsum board.
- **No Moisture Barrier to Install.** With DensShield Tile Backer panels, there is no extra expense or labor to add a waterproof membrane against the framing. Additional vapor barriers behind DensShield Tile Backer are not required or recommended. Cement backers are highly porous, which means a secondary barrier is needed and required by TCNA in wet areas to protect the wall cavity.
- **One Person to Install.** DensShield Tile Backer is so lightweight and easy to handle that a single installer can carry and easily install it, even in difficult applications. The result, of course, is lower installation cost.

34 Cement board maximum wall stud spacing is 16" (406 mm) o.c. Can I use DensShield Tile Backer 24" (610 mm) o.c. for wall framing?

With 1/2" (12.7 mm) DensShield Tile Backer, framing may be spaced up to 24" (610 mm) o.c. with proper blocking or backing located approximately 1" (25 mm) above the top of the tub or receptor and at horizontal joints where tile is to be installed. Using 1/2" 4' x 5' (12.7 mm x 1,220 mm x 1,524 mm) or 1/2" 4' x 8' (12.7 mm x 1,220 mm x 2,438 mm) DensShield Tile Backer blends with 24" (610 mm) o.c. wall framing and reduces the number of seams in the wet area. 5/8" (15.9 mm) DensShield Tile Backer may be used 24" (610 mm) o.c. without back blocking.

35 When I use cement board to keep the stud cavity dry, a moisture barrier membrane should be placed over the studs. Do DensShield Tile Backer panels require the same?

No. DensShield Tile Backer requires no additional moisture barriers. DensShield Tile Backer repels surface water and has a built-in moisture barrier. Cement backer products are unaffected by moisture but are highly porous. TCNA requires use of a secondary barrier behind cement and fiber cement backers in wet areas. Without the additional step of adding a moisture barrier (extra labor and material) to cement backers, moisture and mold damage can occur to the wall cavity.

36 Cement backers can be used on exteriors. Is DensShield Tile Backer recommended for exterior use?

DensShield Tile Backer is not for exterior use.

37 Is DensShield Tile Backer recommended as a fireplace heat shield?

No. DensShield Tile Backer is not designed to be used as a heat shield or radiant barrier.

38 What advantages does 5/8" (15.9 mm) DensShield® Fireguard® Type X have in a fire-rating application?

DensShield Fireguard Tile Backer provides significant advantages to specifiers, installers and owners. Neither insulation nor tile is required for fire rating. Conversely, cement backer requires installation of tile and mineral wool in the cavity. The result is higher costs to achieve the same rating.

GA FILE NO. WP 3615	PROPRIETARY*	1 HOUR FIRE	30 TO 34 STC SOUND
Glass Mat Gypsum Board, Wood Studs			
<p>One layer 5/8" proprietary Type X glass mat water-resistant gypsum backing board applied parallel or at right angles to 2 x 4 wood studs 16" o.c. phosphate coated nails, 1 7/8" long, 1/4" diameter cupped heads, 8" o.c.</p> <p>Joints staggered 16" on opposite sides and covered with 10 x 10 mesh glass tape and tile adhesive. (LOAD-BEARING)</p>			
GP Gypsum	PROPRIETARY GYPSUM BOARD	<p>Thickness: 4 3/4</p> <p>Approx. Weight: 7 psf</p> <p>Fire Test: WHI-495-0853, 5-14-87; WHI-495-0854, 5-15-87</p> <p>Sound Test: See WP 3605 (OR 64-8, 2-4-64)</p>	
	5/8" DensShield® Fireguard®		

With 1/4" (6.4 mm) DensShield Tile Backer panels, tile floors can be kept level with those in adjoining rooms, creating a better overall appearance and helping prevent problems like those often associated with door clearance; ideal for retrofit and floor cabinets.



U.S.A. Georgia-Pacific Gypsum LLC
 Georgia-Pacific Gypsum II LLC
 Canada Georgia-Pacific Canada LP

Sales Information & Order Placement

U.S.A. West: **1-800-824-7503**
 Midwest: **1-800-876-4746**
 South Central: **1-800-231-6060**
 Southeast: **1-800-327-2344**
 Northeast: **1-800-947-4497**

CANADA Canada Toll Free: **1-800-387-6823**
 Quebec Toll Free: **1-800-361-0486**

Technical Information

Georgia-Pacific Gypsum Technical Hotline
 U.S.A. and Canada: **1-800-225-6119**
www.gpgypsum.com



TRADEMARKS DENSSHIELD, FIREGUARD, DENS, BUILDING REPUTATIONS TOGETHER and the GEORGIA-PACIFIC logo are trademarks owned by or licensed to Georgia-Pacific Gypsum LLC. DUROCK is a trademark owned by U.S. Gypsum Company. PERMABASE is a trademark owned by National Gypsum Corporation. HARDIBACKER is a trademark owned by James Hardie. WONDERBOARD is a trademark owned by Custom Building Products. LATICRETE is a trademark owned by LATICRETE International, Inc. TCNA logo is a Trademark of Tile Council of North America. USGBC and related logo is a trademark owned by the U.S. Green Building Council and is used by permission.



WARRANTIES, REMEDIES AND TERMS OF SALE

For current warranty information for this product, please go to www.gpgypsum.com and select the applicable product for warranty information. All sales by Georgia-Pacific are subject to our Terms of Sale available at www.GPGypsum.com.

UPDATES AND CURRENT INFORMATION

The information in this document may change without notice. Visit our website at www.GPGypsum.com for updates and current information.

CAUTION For product fire, safety and use information, go to www.buildgpc.com/safetyinfo or call 1-800-225-6119.

HANDLING AND USE—CAUTION This product contains fiberglass facings which may cause skin irritation. Dust and fibers produced during the handling and installation of the product may cause skin, eye and respiratory tract irritation. Avoid breathing dust and minimize contact with skin and

eyes. Wear long sleeve shirts, long pants and eye protection. Always maintain adequate ventilation. Use a dust mask or NIOSH/MSHA approved respirator as appropriate in dusty or poorly ventilated areas.

FIRE SAFETY CAUTION Passing a fire test in a controlled laboratory setting and/or certifying or labeling a product as having a one-hour, two-hour, or any other fire resistance or protection rating and, therefore, as acceptable for use in certain fire rated assemblies/systems, does not mean that either a particular assembly/system incorporating the product, or any given piece of the product itself, will necessarily provide one-hour fire resistance, two-hour fire resistance, or any other specified fire resistance or protection in an actual fire. In the event of an actual fire, you should immediately take any and all actions necessary for your safety and the safety of others without regard for any fire rating of any product or assembly/system.

Some of our products have been certified by Scientific Certification Systems (SCS). SCS is an internationally recognized third-party evaluation, testing and certification organization. Its program spans a wide cross-section of the economy, including manufacturing and retailing, consumer products, the energy industry, and the home improvement and construction sectors. For details on specific Georgia-Pacific Gypsum products and plants, please contact our Technical Hotline at 800-225-6119.